



特点

- 芯片与底板电气绝缘，2500V交流电压
- 国际标准封装：全压接结构，优良的温度特性和功率循环能力
- 350A以下模块皆为强迫风冷，400A以上模块，风冷，水冷先用

$I_{T(AV)}$	600A
$V_{DRM}/V_{RRM}$	500-2500V
$I_{TSM}$	13 KA
$I^2t$	845 $10^3 a^2s$

典型应用

- 交直流电机控制，各种整流电源
- 工业加热控制，调光，无触发点开关
- 电机软起动，静止无功补偿
- 电焊机，变频器，UPS电源，电池充放电

符号	参数	测试条件	结温 $T_j(°C)$	参数值			单位
				最小	典型	最大	
$I_{T(AV)}$	通态平均电流	180° 正弦半波，50HZ 双面散热， $T_C=85°C$	125			600	A
$I_{T(RMS)}$	方均根电流		125			924	A
$V_{DRM}$ $V_{RRM}$	断态重复峰值电压 反向重复峰值电压	$V_{DRM} \& V_{RRM} \text{ tp}=10\text{ms}$ $V_{DSM} \& V_{RSM}=V_{DRM} \& V_{RRM}+200\text{V}$	125	500		2500	V
$I_{DRM}$ $I_{RRM}$	断态重复峰值电流 反向重复峰值电流	$V_{DM}=V_{DRM}$ $V_{RM}=V_{RRM}$	125			40	mA
$I_{TSM}$	通态不重复浪涌电流	10ms 底宽，正弦半波	125			13.0	KA
$I^2t$	浪涌电流平方时间积	$V_R=0.6V_{RRM}$				845	$A^{2S} \cdot 10^3$
$V_{TO}$	门槛电压		125			0.80	V
$r_T$	斜率电阻					0.53	$m\Omega$
$V_{TM}$	通态峰值电压	$I_{TM}=1800A$	25			1.35	V
dv/dt	断态电压临界上升率	$V_{DM}=0.67V_{DRM}$	125			800	V/us
di/dt	通态电流临界上升率	$I_{MT}=52A$ 门极触发电流幅值 $I_{GR}=1.5A$ 门极电流上 $\leq$ 升时间 $t_r \leq 0.5\mu s$	125			100	A/us
$I_{GT}$	门极触发电流	$V_A=12V, I_A=1A$	25	30		200	mA
$V_{GT}$	门极触发电压			1.0		3.0	V
$I_H$	维持电流			20		200	mA
$V_{GD}$	门极不触发电压	$V_{DM}=0.67V_{DRM}$	125	0.2			V
$R_{th(j-c)}$	热阻抗（结至壳）	180° 正弦波，单面散热				0.073	$°C/W$
$R_{th(c-h)}$	热阻抗（壳至散）	180° 正弦波，单面散热				0.073	$°C/W$
$V_{iso}$	绝缘电压			2500			V
$F_M$	安装扭矩（M5）				12		N-m
	安装扭矩（M6）				6		N-m
$T_{stq}$	储存温度			-40		125	$°C$
$W_t$	质量						g
Outline	外形						

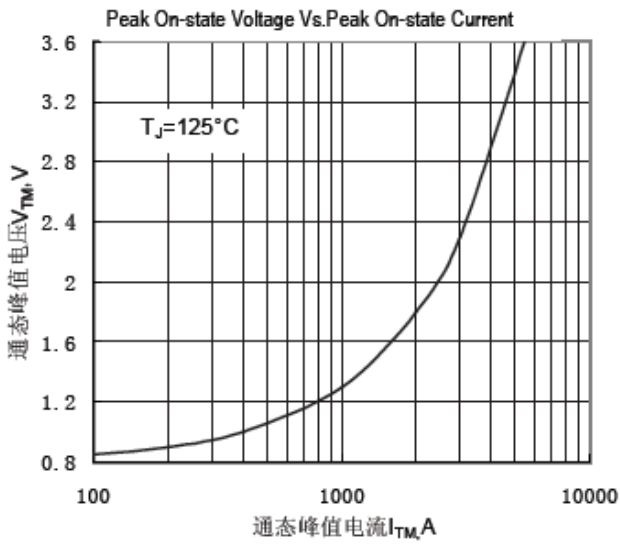

Fig.1 通态伏安特性曲线

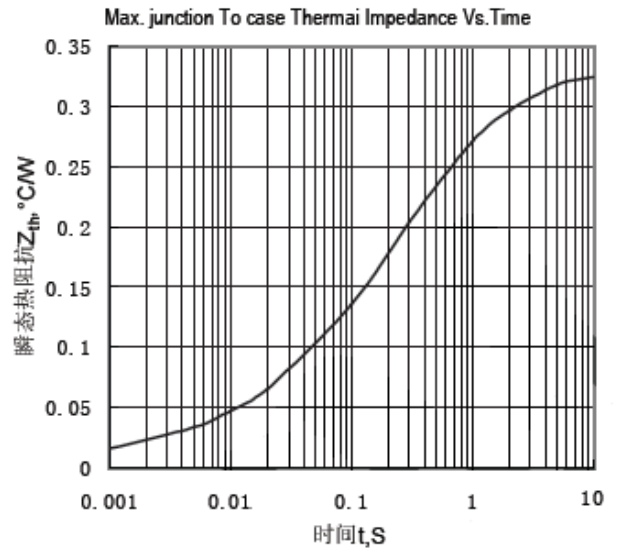

Fig.2 结至管壳瞬态热阻抗曲线

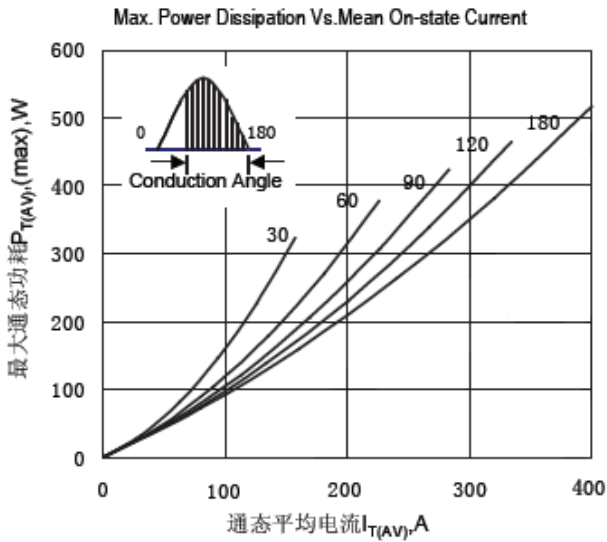

Fig.3 最大功耗与平均电流关系曲线

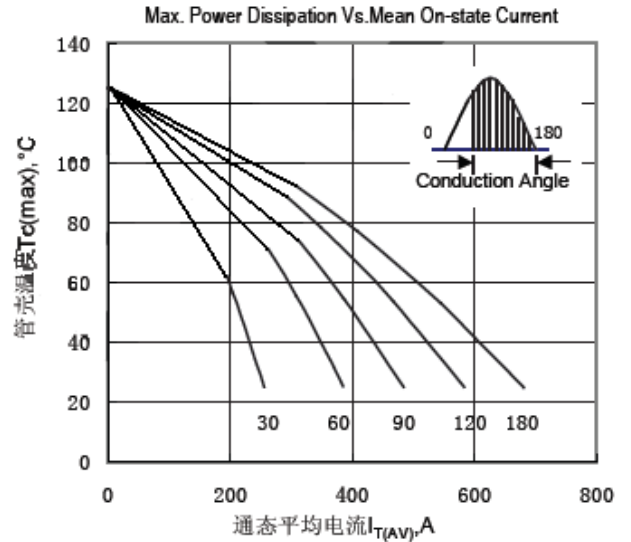

Fig.4 管壳温度与通态平均电流关系曲线

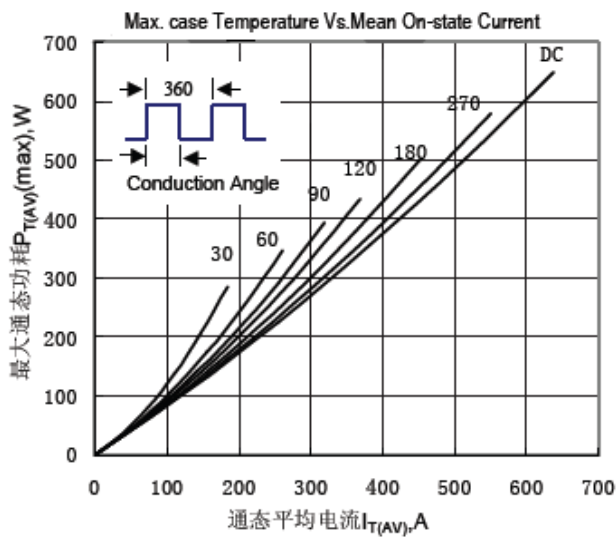

Fig.5 最大功耗与平均电流关系曲线

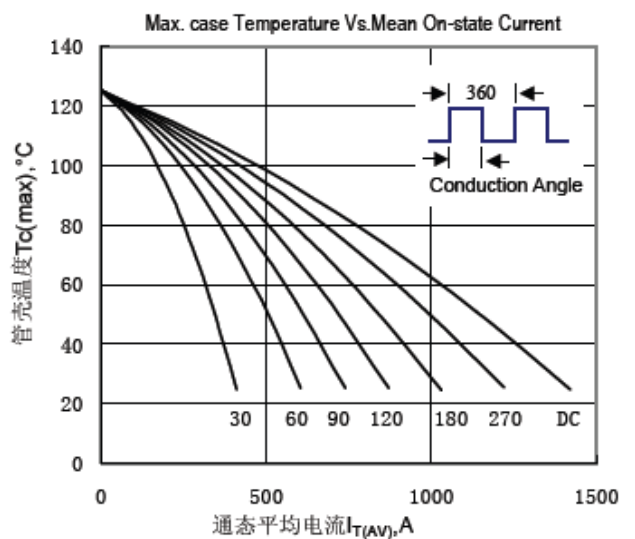

Fig.6 管壳温度与通态平均电流关系曲线

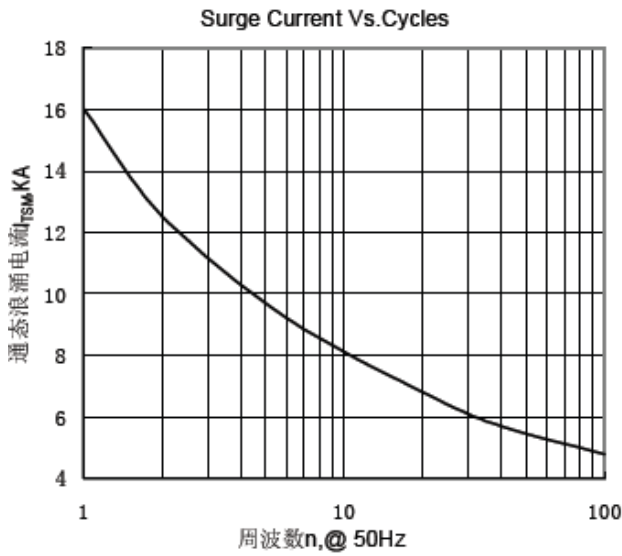

Fig.7 通态浪涌电流与周波数的关系曲线

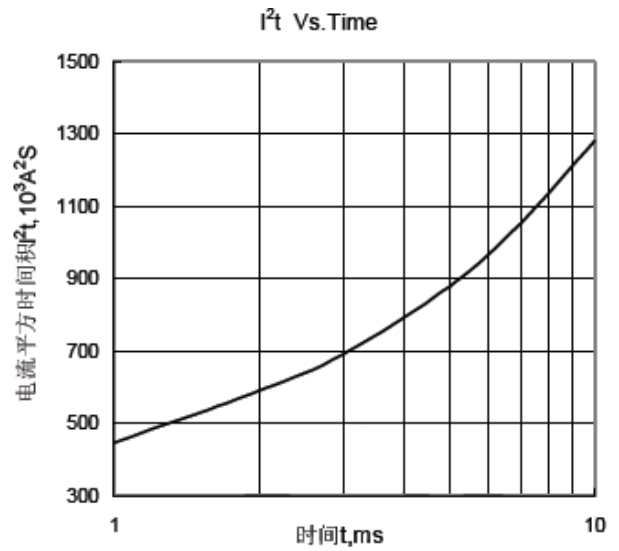

Fig.8  $I^2t$  特性曲线

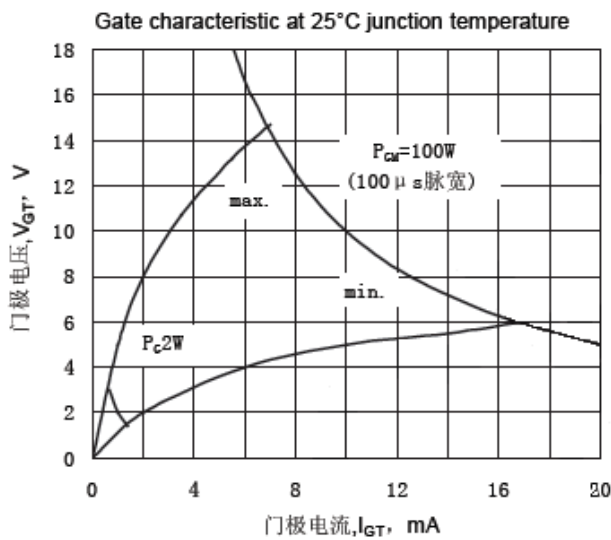

Fig.9 门极功率曲线

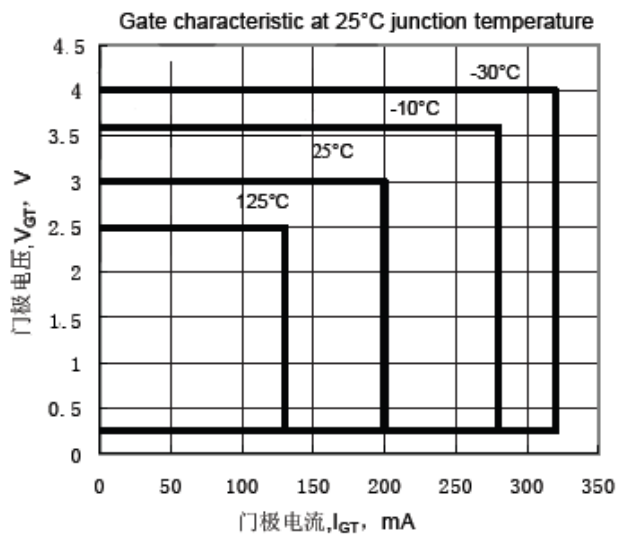

Fig.10 门极触发特性曲线

外形图:



图 1



图 2

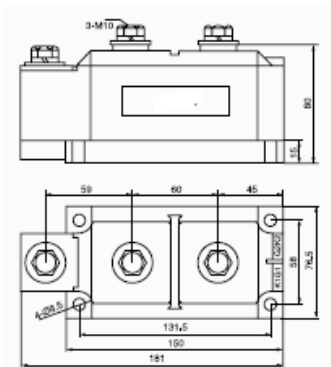

图 3

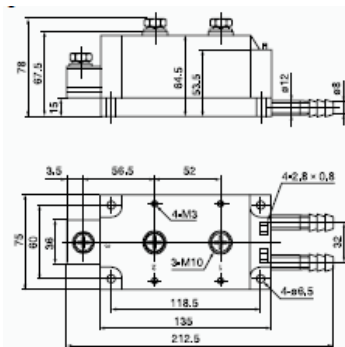

图 4

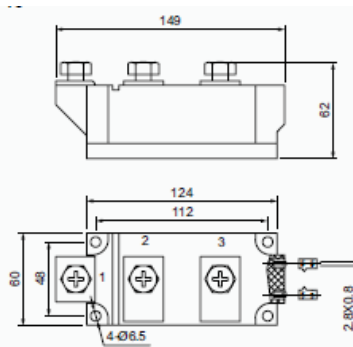

线路图：

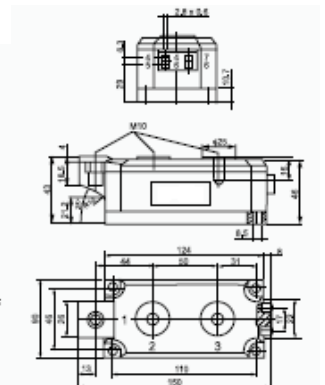