

特点

- 芯片与底板电气绝缘，2500V交流电压
- 采用进口玻璃钝化芯片焊接，优良的温度特性进口和功率循环能力
- 体积小，重量轻

典型应用

- 变频器
- 交直流电机控制
- 各种整流电源

$I_{F(AV)}$	55A
V_{RRM}	500-2500V
I_{FSM}	1.3 KA
I^2t	8.6 $10^3 a^2s$

符号	参数	测试条件	结温 $T_J(°C)$	参数值			单位
				最小	典型	最大	
$I_{F(AV)}$	正向平均电流	180° 正弦半波, 50HZ 单面散热, $T_C=100°C$	150			55	A
$I_{F(RMS)}$	方均根电流		150			86	A
V_{RRM}	反向重复峰值电压	$V_{RRM} tp=10ms$ $V_{RSM}=V_{RRM}+200V$	150	500		2500	V
I_{RRM}	反向重复峰值电流	$V_{RM}=V_{RRM}$	150			8	mA
I_{FSM}	正向不重复浪涌电流	10ms 底宽, 正弦半波 $V_R=0.6V_{RRM}$	150			1.3	KA
I^2t	浪涌电流平方时间积					8.6	$A^{2S} \cdot 10^3$
V_{FO}	门槛电压		150			0.80	V
r_F	斜率电阻					3.47	$m\Omega$
V_{FM}	正向峰值电压	$I_{FM}=170A$	25			1.10	V
$R_{th(j-c)}$	热阻抗 (结至壳)	180° 正弦波, 单面散热				0.77	$°C/W$
$R_{th(c-h)}$	热阻抗 (壳至散)	180° 正弦波, 单面散热				0.2	$°C/W$
V_{iso}	绝缘电压	50Hz, R.M.S, $t=1min, I_{iso}: 1mA(max)$		2500			V
F_M	安装扭矩 (M5)					4	N-m
	安装扭矩 (M6)					6	N-m
T_{stq}	储存温度			-40		125	$°C$
W_t	质量					115	g
Outline	外形						



Peak forward Voltage Vs. Peak forward Current

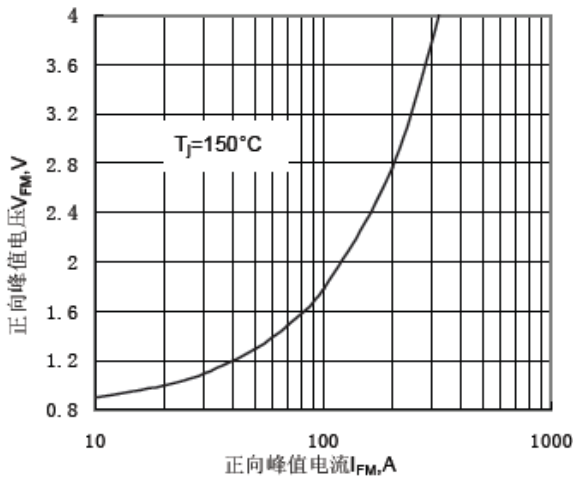

Fig.1 正向伏安特性曲线

Max. junction To case Thermal Impedance Vs. Time

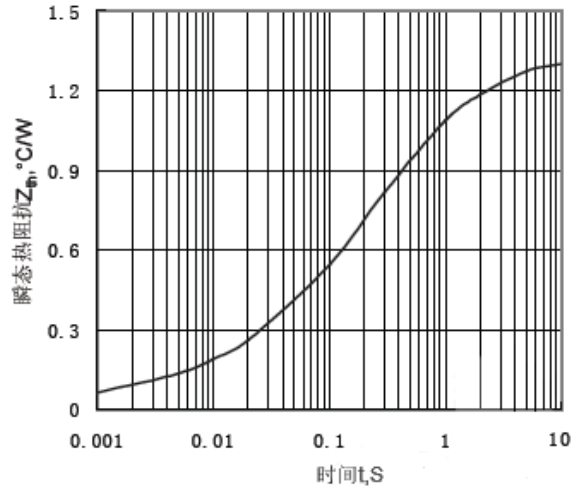

Fig.2 瞬态热阻抗曲线

Max. Power Dissipation Vs. Mean forward Current

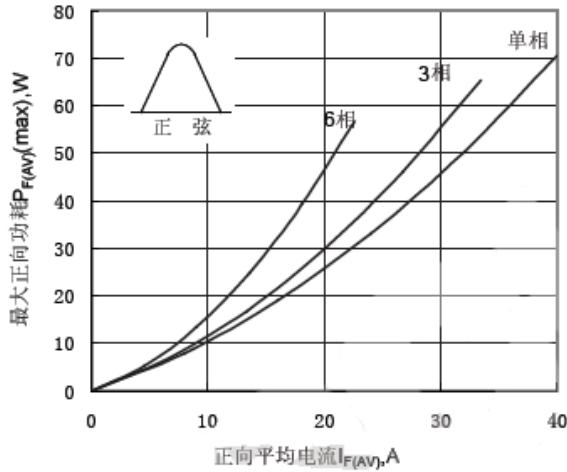

Fig.3 最大正向功耗与平均电流关系曲线

Max. Power Dissipation Vs. Mean forward Current

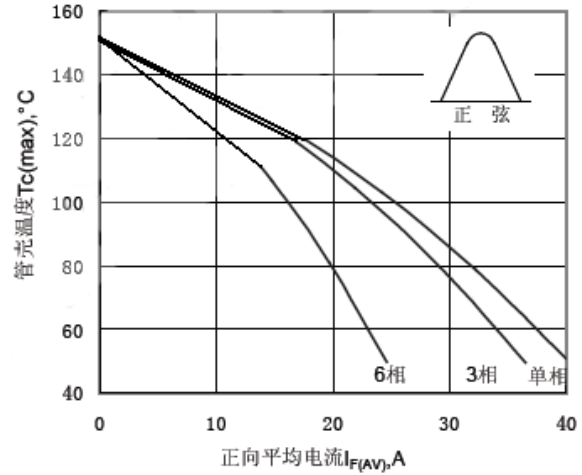

Fig.4 管壳温度与正向平均电流关系曲线

Max. case Temperature Vs. Mean forward Current

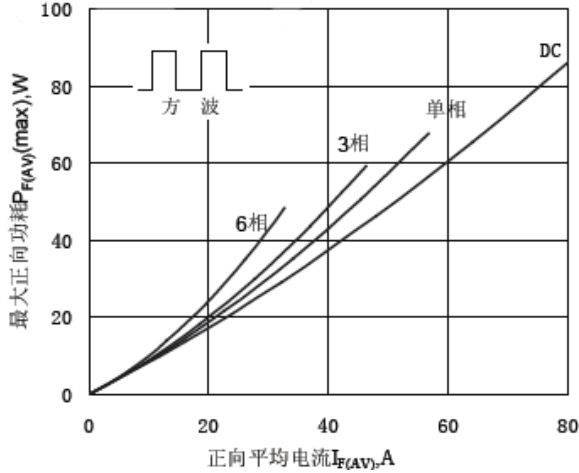

Fig.5 最大正向功耗与平均电流关系曲线

Max. case Temperature Vs. Mean forward Current

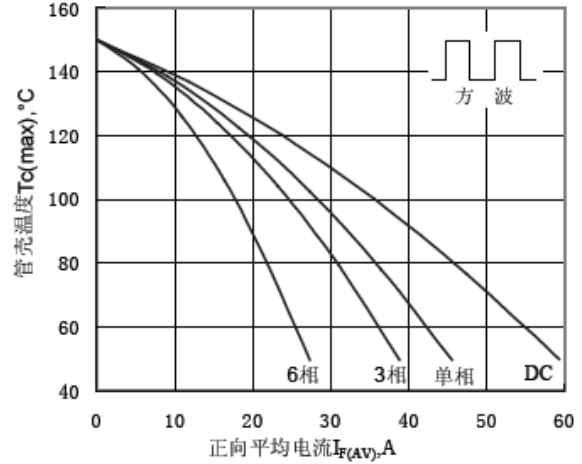

Fig.6 管壳温度与正向平均电流关系曲线

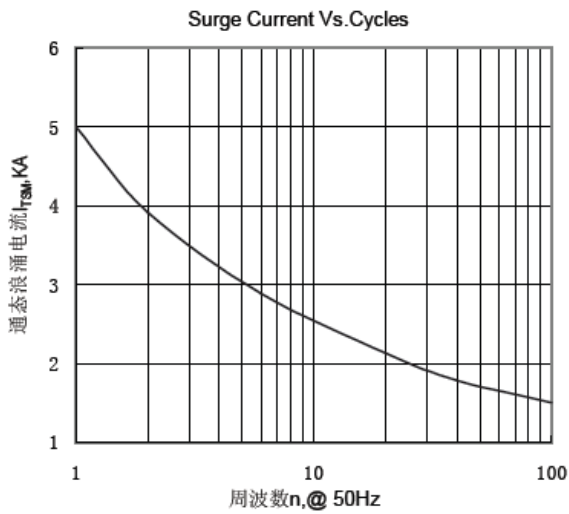

Fig.7 通态浪涌电流与周波数的关系曲线

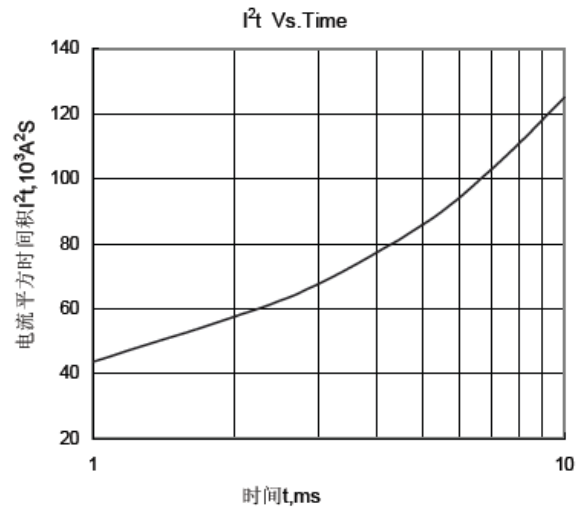

Fig.8 I^2t 特性曲线

外形图:



图 1

图 2

图 3

线路图:

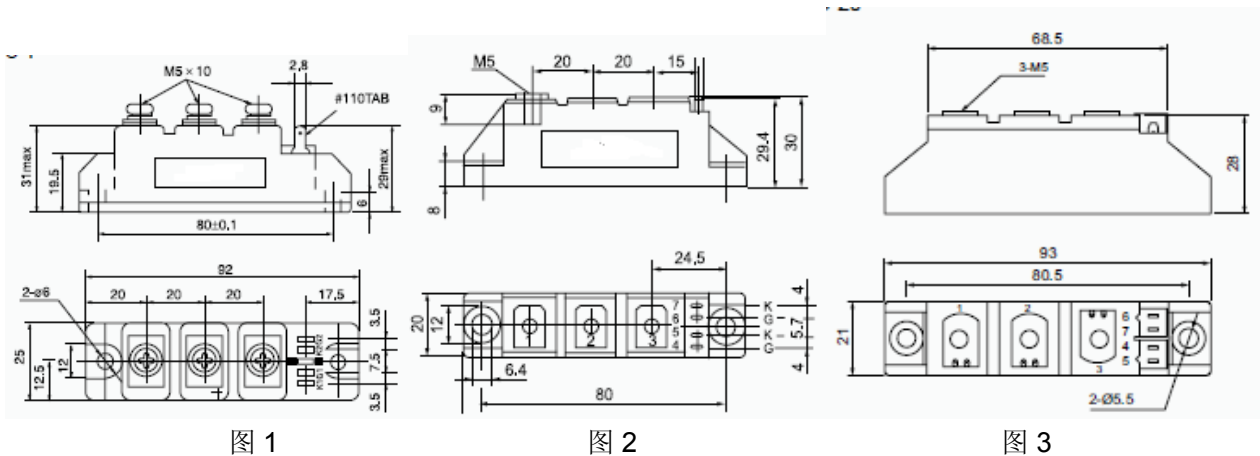